

- BÁCULO 12X1,5 / 60 / 4
- COLUMNA 10 / 6 / 3

DETALLE DE CANALIZACIONES

ZANJA EN ACERA

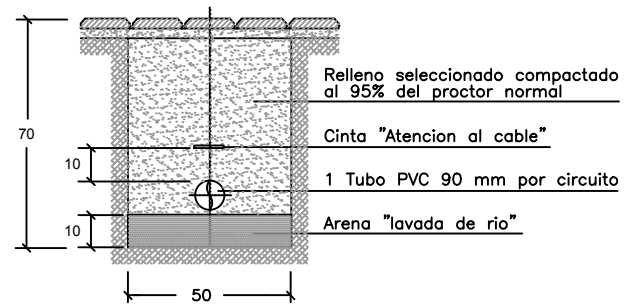

ZANJA EN CRUCE DE CALZADA

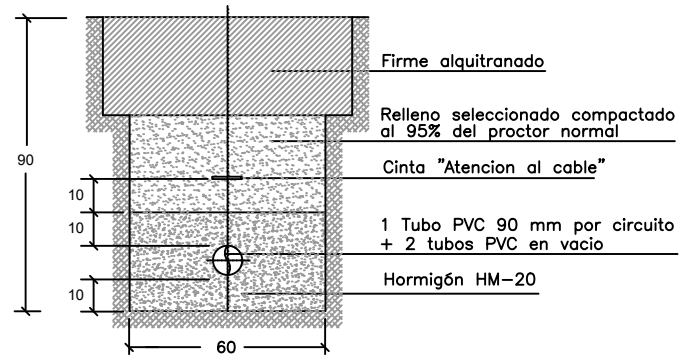

LUMINARIAS

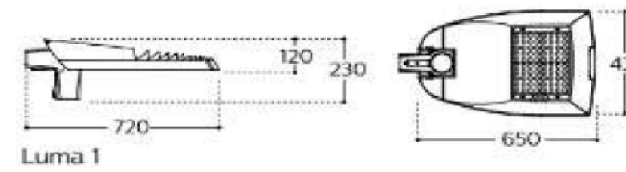

LUMA 1

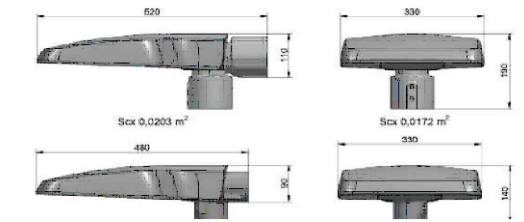

CLEA WAY

DETALLE DE ARQUETA

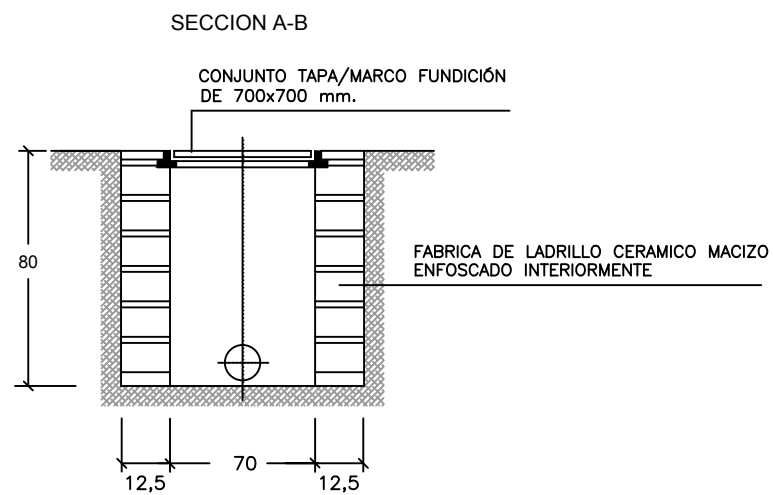

PLANTA

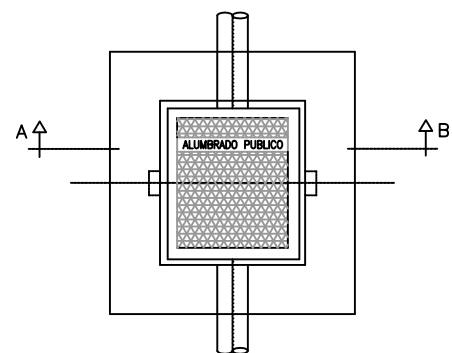

COLUMNA

ALZADO

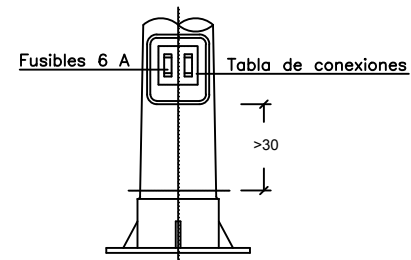

PLANTA

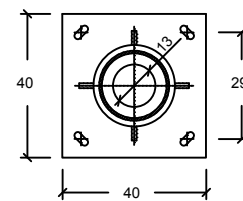

ARMARIO

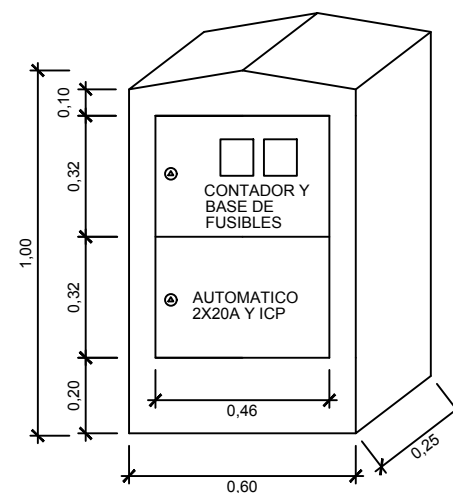

CIMENTACION DE COLUMNA CON ARQUETA ADOSADA

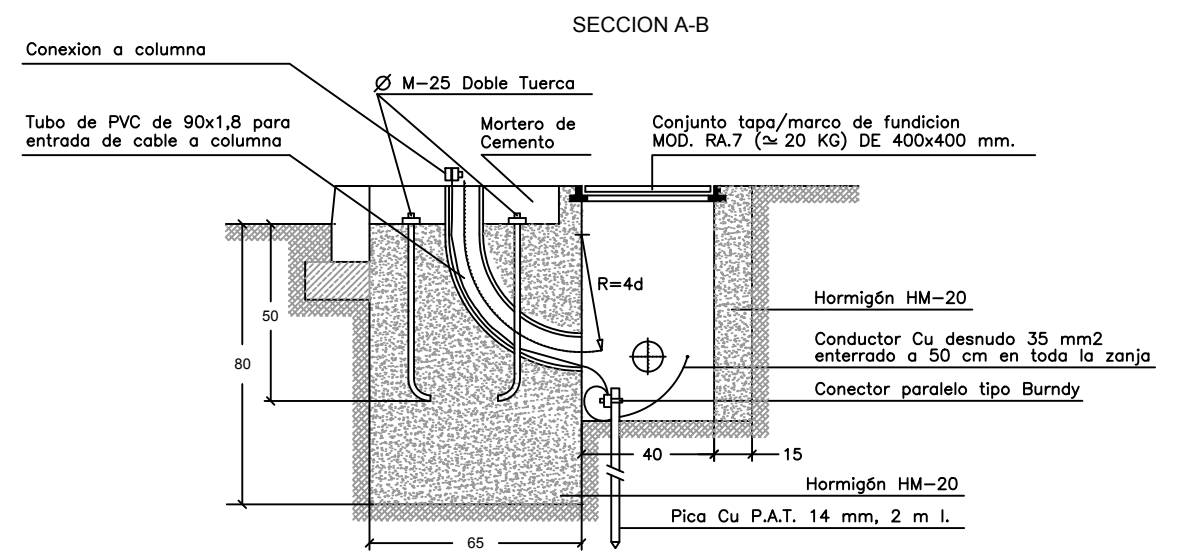

PLANTA

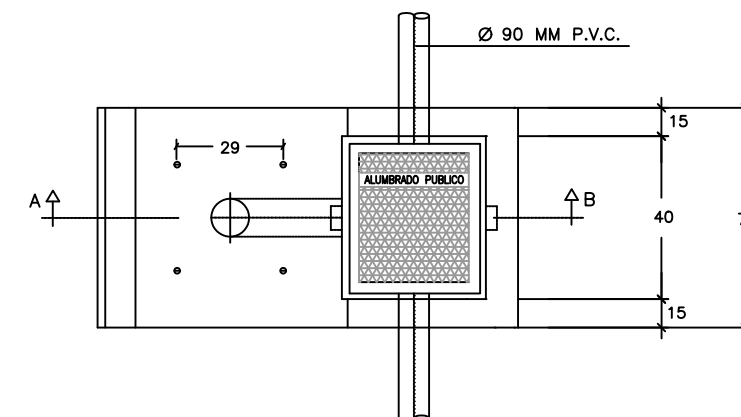

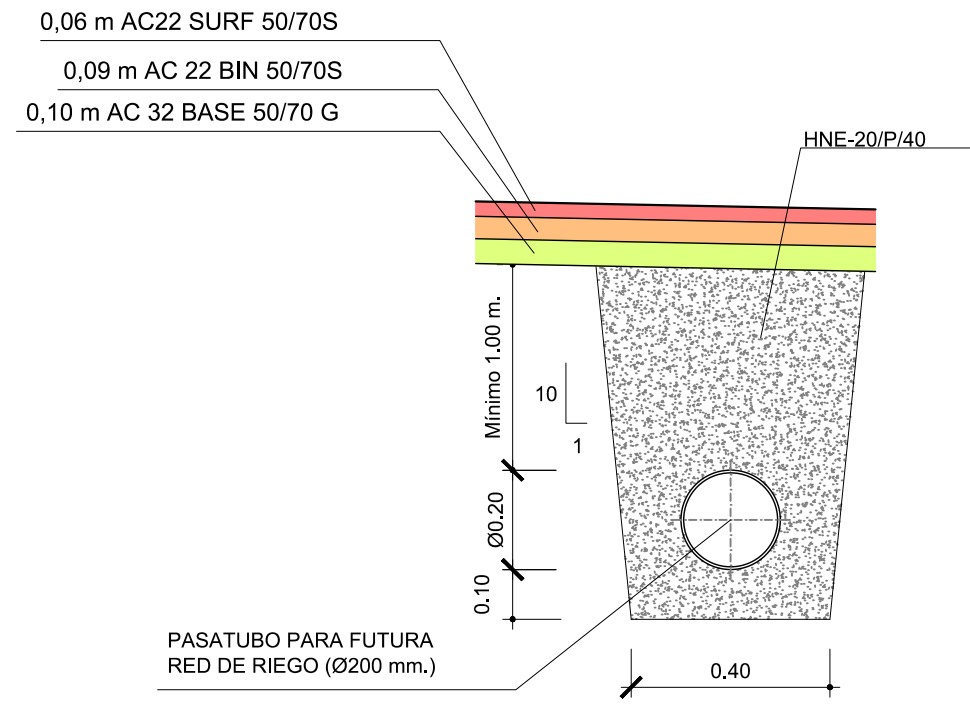
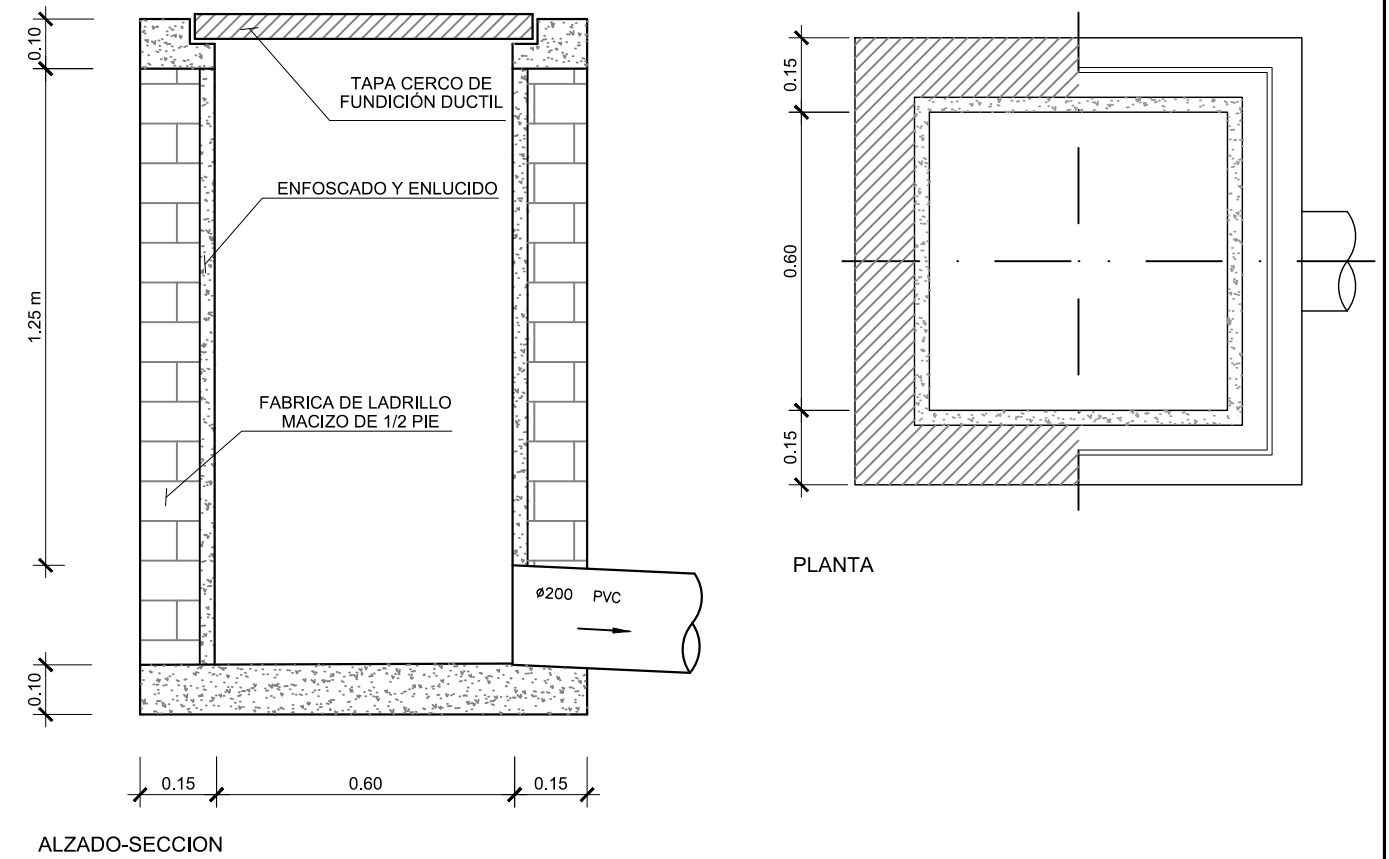
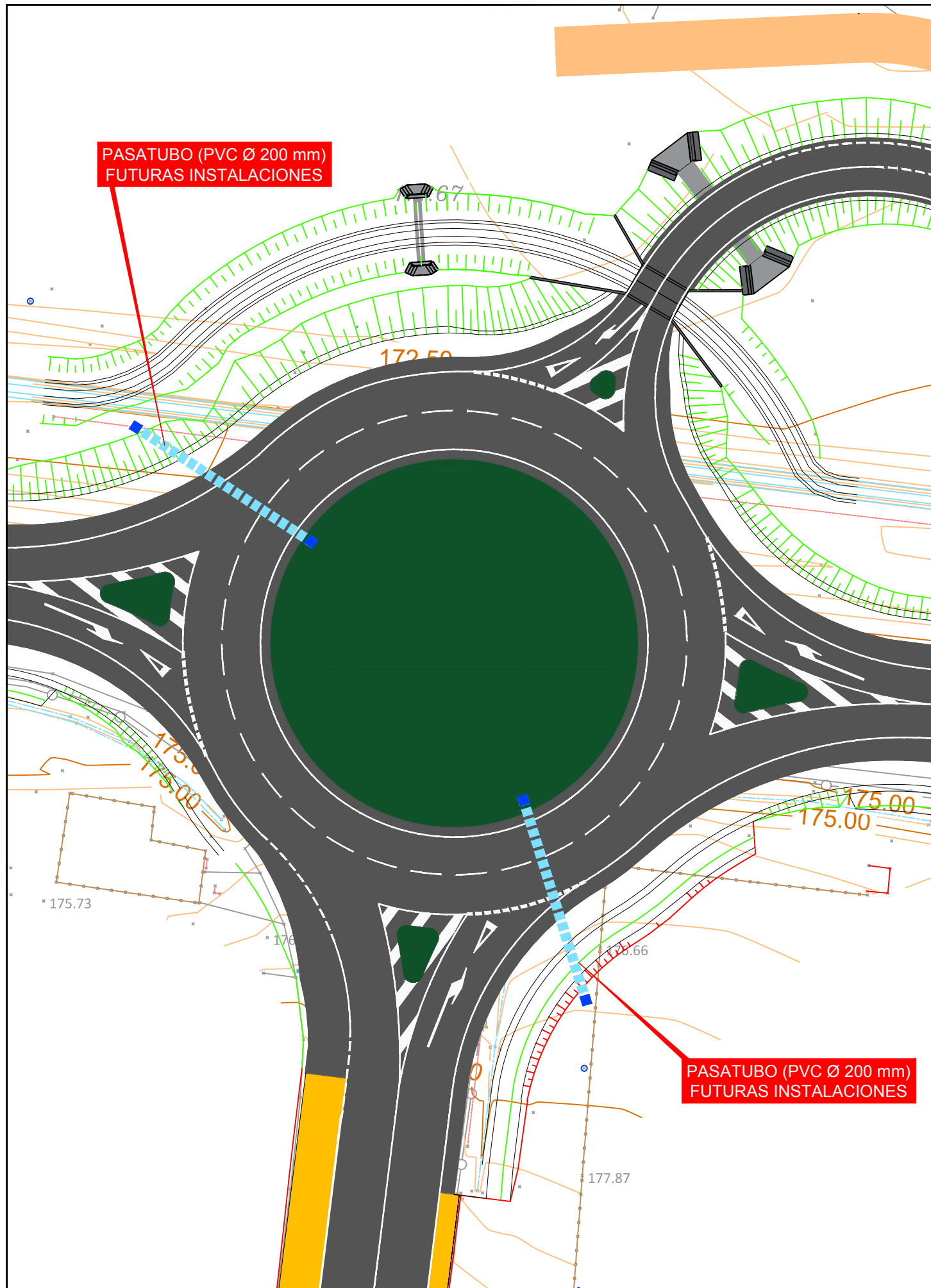

SECCIÓN TIPO DE ZANJA